



# **Saudi Games**

## **Karting Championship 2024**

### **Appendix 1**

### **Technical Regulations 2024**



**Organized by Saudi Games**  
In Association With  
Saudi Automobile & Motorcycle Federation

Version 19.08.2024

# REGULATIONS

The final text of these Technical Regulations shall be the English version, which will be used, should any dispute arise as to their interpretation. Headings in this document are for ease of reference only and do not form part of the regulations.

The Saudi Games shall be run in accordance with these Supplementary Regulation and the following regulations:

- *2024 Saudi Games Technical Regulations (Karting)*
- *2024 RMC Global Technical Regulations*
- *2024 CIK-FIA Technical Regulations*
- *2024 FIA International Sporting of the FIA*
- *2024 CIK-FIA General Prescriptions*
- *2024 CIK-FIA Specific Prescriptions*

Anything which is not expressly allowed in the technical regulations is forbidden.

## 1. GENERAL

### 1.1 CATEGORIES

Karts used in the Saudi Games are divided into the following groups:

- Rotax 125 Senior MAX (cylinder capacity 125 cc)

### 1.2 AMOUNT OF EQUIPMENT

During the event (from non-qualifying practice to the Final), the maximum amount of equipment is:

- 1 chassis. In case of an accident, the driver can only change one time the chassis (frame) after the authorization of the Technical Scrutineers. In this case, the chassis must be the same brand and model of the previous one.
- Tyres:
  - 1 set of dry tyres (total 2 front tyres plus 2 rear tyres) for the Qualifying tryouts.
  - 1 set of dry tyres for the Finals.
  - For the Free Practices, the set of tyres are free. However, they must be the same brand and model of the official set (Vega XH3).
  - In case of mechanical failure of a tyre, each driver may exchange maximum 1 tyre, except if failure has been caused on purpose/misuse. In case of a mechanical failure of a tyre, the technical scrutineer will determine if the failure was due to material defect or has been caused on purpose/misuse. The damage must be reported to the scrutineer immediately after the on-track action where the damage occurred, and prior to leaving the parc ferme / scale area. The technical scrutineer's decision will be final and not subject to protest or appeal.
  - If the failure has not been caused on purpose/misuse, a new tire will be provided as replacement.
- 1 engine. However, if there's a problem with the engine, it is possible to register a 2<sup>nd</sup> engine. The first engine registered stays in Parc Fermé until the end of the event and it is not possible to use it again. If a 2<sup>nd</sup> engine is registered, the driver will be given the following penalty:
  - If it happens before or during the Qualifying tryouts, the driver will be given 10 seconds penalty to the best time lap.
  - If it happens after the Qualifying, the driver will start the Finals on the pit exit lane.

## 2. EQUIPMENT

### 2.1 CHASSIS

Chassis with valid FIA Homologation since 2020 and approved by sporting at SAMF will be sanctioned to race.

Maximum diameter of rear axle = 50 mm, minimum wall thickness according to CIK-FIA rules.

Maximum overall width = 1400 mm.

Brake system must work on rear wheels only and have a valid CIK-FIA homologation. Front brakes are not allowed.

[In case of change of the chassis it is a mandatory that the new chassis must be inspected by the scrutineers.](#)

#### 2.1.1 CHASSIS PROTECTION

It is permitted to attach chassis protectors to the chassis rails left, right and front. The only material permitted is plastic. The installation and wear must satisfy the scrutineers of the event.

### 2.2 BODYWORK

In accordance with SAMF and CIK-FIA regulations.

The use of a homologated Front Fairing and of the homologated Front Fairing Mounting Kit of the bodywork homologation is mandatory for all categories, in accordance with CIK Specific Prescriptions article 31, CIK General Prescriptions article 2.3.3 and CIK Technical Drawing No 2.2 & 2.2.1.

### 2.3 TYRES

		Front Tyre	Rear Tyre
Dry	Vega XH3	4.60 / 10.0 - 5	7.10 / 11.0 - 5

- Strictly no modifications or tire treatment allowed.
- Recommended equipment to detect tire treatment is Mini-RAE-Lite.
- Threshold value of maximum 4 ppm is recommended.
- Tires must be mounted according to the sense of rotation defined on the tire.

### 2.4 DATA ACQUISITION

Systems which permit the reading/recording of following data only are allowed:

- Lap time
- Engine rpm (by induction on the high-tension cable)
- Two indications of temperature
- The speed of one wheel
- Acceleration in X/Y direction
- Position (via GPS system)
- Steering wheel angle sensor

Connection of the data acquisition system to the original Rotax battery is allowed.

### 2.5 COMPOSITE MATERIALS

Composite materials (carbon-fiber, etc.) are banned except for the seat, floor tray and brake disc. Alloys from different metals / substances are not considered as composite materials.

### 2.6 SAFETY EQUIPMENT

Race suit, helmet, kart boots, gloves and other items of driver protection must comply with Article 7 of the CIK-FIA Technical Regulations.

### 2.7 FUEL/OIL

Petrol: unleaded commercial quality from petrol station, 95 octane.

Oil: XPS KART TEC fully synthetic 2T or XPS DYE fully synthetic 2T is allowed supplied by the organizer.

For XPS DYE fuel color must show up green under led light (e.g. INOVA X5 led light).

## 2.8 ADVERTISING ON ENGINES

Sponsor stickers, badges, etc. (ROTAX, MOJO, XPS, Saudi Games 2024) are allowed on the engine or any of its accessories.

## 3. ENGINES

Only engines which have been purchased and sealed by the factory or authorized dealer or distributor. By sealing an engine, the organizer takes over the responsibility for the conformity of the engine according to the valid Technical Specification. A brand-new engine purchased in an authorized dealer, or distributor, or official service centre is always checked according to the Technical Specification before sealing.

The engines must be sealed with specific ROTAX engine seals provided by authorized dealer or distributor or its official service centre (black anodised aluminium seal with "ROTAX" logo and 6-digit serial number and bar code - see right picture). **ONLY SEALS WITH BARCODE ARE LEGAL TO BE USED!**

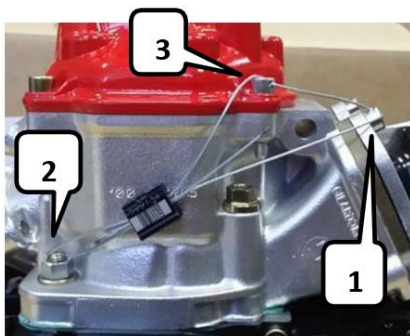

By means of the steel cable the engine must be sealed on one allen screw of the intake flange (1), one stud screw of cylinder (2) and one allen screw of the cylinder head cover (3) - see left picture.

**It is mandatory to pass the end of the sealing wire through the seal twice (as in picture).**

After sealing the engine, the seal thread must be squeezed using ROTAX calliper 276110 (above picture).

Upon every new sealing of an engine authorized dealer or distributor (or their Service Centres) is responsible for the following amendments of the Engine Identity Card which belongs to the owner of the engine:

- Serial no. of the engine
- Serial no. of the engine seal
- Stamp and signature of the Company to be able to detect at Scrutineering which authority has checked and sealed the engine.

At Scrutineering the driver must present:

- The engine(s) with undamaged engine seal(s)
- The Engine Identity Card(s) showing the matching engine serial no.(s), the matching engine seal no.(s) and the stamp(s) and signature(s) of the authority that has checked and sealed the engine(s).



The sealing of engines helps to reduce the times for Scrutineering at races as during the race event only the accessories (carburettor, exhaust, radiator...) need to be checked.

Of course, Scrutineers can request to open and re-check an engine according to the Technical Specification before or after a race or in case of a protest. If an engine seal has been broken (for whatever reason), the engine must be checked completely for compliance according to the Technical Specification. Re-sealing may only then be carried out at the discretion of organizer. If organizer suspects that an engine has been tampered with in any way, that engine will be excluded from competition and will not be resealed under any circumstances.

**It is the responsibility of the competitor that all components outside the seal are in line with the Technical Regulations.**

## 4. ENGINE MODIFICATIONS, REPAIRS AND ADDITIONS

### 4.1 MODIFICATIONS

Neither the engine nor any of its ancillaries may be modified in any way. "Modified" is defined as any change in form, content or function that represents a condition of difference from that originally designed. This is to include the addition and / or omission of parts and/or material from the engine package assembly unless specifically allowed within these rules. The adjustment of elements specifically designed for that purpose shall not be classified as modifications, i.e., carburettor and exhaust valve adjustment screws.

The repair of a thread on the crankcase (maximum of three threaded holes per crankcase) using a "Heli - coil" or similar is allowed.

Exception: The threads located under the crankcase to fix the crankcase on the engine mount may be repaired as needed.

The repair of a thread on the cylinder (maximum of three threaded holes per cylinder) using a "Heli - coil" or similar is allowed.

Genuine ROTAX components only that are specifically designed and supplied for the 125 Senior MAX engine are legal, unless otherwise specified.

**ANYTHING WHICH IS NOT EXPRESSLY ALLOWED IN THE TECHNICAL REGULATIONS IS FORBIDDEN.**

### 4.2 INTERNAL ADDITIONS

No additional material may be added except in the case of engine repairs and shall only restore the engine or components to original specifications.

The use of thermal barrier coatings/ceramic coatings on or in the engine and on or in the exhaust system is prohibited.

The use of anti-friction coatings in or on the engine/engine components is prohibited.

Example of allowed repairs (but not limited to):

- Example 1, Damaged Cylinder due to freezing.

It is allowed to repair the cracked cylinder by welding.

It would also be allowed to dress / finish the area marked red to restore the part to the original specification.

It would not be allowed to dress / finish areas not effected by damage.



- Example 2, Exhaust valve flange area repair.

Exhaust valve flange area (marked red) is damaged through contact wear with the exhaust valve.

It would be permitted to repair the red marked area only.

To dress or finish the area which was repaired in the red area would be allowed to ensure the engine is restored to its original specification.



**Removal of additional, as supplied material from the surrounding areas is strictly forbidden.**

### 4.3 LEGAL ADDITIONS

Chain guard, engine mount, temperature gauge and tachometer/hour meter, catch cans for liquids with mounting brackets.

Customizing the cylinder head cover by painting is legal.

#### **4.4 NON-TECH ITEMS**

Non-original fasteners, circlips, washers, throttle cable housing, fuel and pulse line (type and size) as well as length of coolant hoses are allowed unless otherwise specified.

#### **4.5 MEASUREMENTS**

When taking any dimensional reading of the following technical regulations, in the order of accuracy of 0.1 mm (or even more precise), the temperature of the part must be between +10°C and +30°C.

In order to avoid excessive noise and exhaust emissions, revving the engine in the paddock area is not permitted. A short function test of maximum time 5 seconds is permitted within the start servicing park (after fitting of fuel tanks) before the Pre-Grid.

**It is the responsibility of the competitor to check his/her equipment (all components outside the engine seal and mentioned below), to ensure that his/her equipment is in line with all technical specifications below!**

# 5. TECHNICAL SPECIFICATION WITHIN THE ENGINE SEAL FOR ROTAX MAX KART ENGINES

## 5.1 SQUISH GAP

The crankshaft must be turned by hand slowly over top dead centre to squeeze the tin wire. The squish gap must be measured on the left and right side in the direction of the piston pin. The average value of the two measurements counts.

**125 Senior MAX** 2 mm tin wire (Rotax 580130)

Minimum  
1,00 mm

## 5.2 COMBUSTION CHAMBER INSERT

5.2.1 Cast identification code has to be either:

- 223389
- 223389 1
- 223389 2
- 223389 2/1
- 223389 2/2

5.2.2 Casted wording "ROTAX" and/or "MADE IN AUSTRIA" must be shown (see picture right).



5.2.3 Height [H] of combustion chamber insert has to be 28,80 mm +/- 0,2 mm.

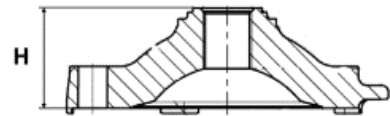

5.2.4 The profile of the combustion chamber insert has to be checked with a template (ROTAX 277390). The crack of light between the template and the profile of the combustion chamber insert must be the same over the whole profile.



## 5.3 PISTON WITH RING ASSEMBLY

5.3.1 Original, coated, aluminium, cast piston with one piston ring. The piston has to show on the inside the cast wording "ELKO" [1] and "MADE IN AUSTRIA" [2].

5.3.2 Machined areas are:

- Top end of piston
- Outside diameter
- Groove for the piston ring
- Bore for the piston pin
- Inside diameter at bottom end of piston and some pre-existing factory removal [3] of flashing at the cut out of the piston skirt

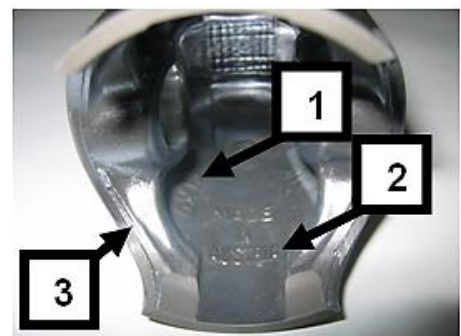

All other surfaces are not machined and have cast surface.

Any mechanical treatment or rework of the piston is forbidden, (Altering the pistons profile by reworking carbon build-up is forbidden, if carbon is removed it must be consistently removed across the entire surface without altering the profile of the piston itself).

Example, selectively removing carbon in the squish measurement areas is forbidden.

### 5.3.3 Original, magnetic, rectangular piston ring.

Ring height: 0,98 +/- 0,02 mm.

Piston ring is marked either with:

- ROTAX 215547
- ROTAX 215548
- ROTAX 215548 X
- I ROTAX 215548 X



The piston ring is legal also if just parts of the marking are still visible.

## 5.4 PISTON PIN

5.4.1 Piston pin is made out of magnetic steel.

5.4.2 Dimensions must be according to the drawing.

5.4.3 The minimum weight of the piston pin must not be lower than 31,00 grams.

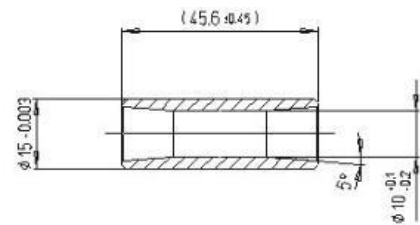

## 5.5 CYLINDER

Light-alloy-cylinder with GILNISIL-plating.

Any re-plating of cylinder is not allowed.

Maximum bore of cylinder = 54,035 mm (measured 10 mm above the exhaust port).

Cylinder has to be marked with the "ROTAX" logo (see pictures below).

### 125 Senior MAX:

Cylinder with one main exhaust port and exhaust valve.

Cylinders marked (cast or machined) with identification code 223993 only are legal to be used.



#### 5.5.1 Height of cylinder

Measured with a digital calliper min. length 200 mm.

	Height	Tolerance
<b>125 Senior MAX</b>	87,00 mm	+0,1 mm -0,05 mm



#### 5.5.2 Cylinder surfaces

5.5.2.1 All transfer ports and passages have cast finish surface except some removal (done by the manufacturer) of cast burr at the inlet passage, exhaust port and passages. All ports have chamfered edges to prevent ring snagging. Any additional machining is not permitted.

The top edge of exhaust port may show some pre-existing machining from the manufacturer. The sealing flange for the exhaust socket may show signs of machining from the manufacturer.



5.5.2.2 All ports have chamfered edges. Any additional machining is not permitted.

Cylinders marked 223993, 223994 and 613933 the upper edge of the central boost port may show factory machining

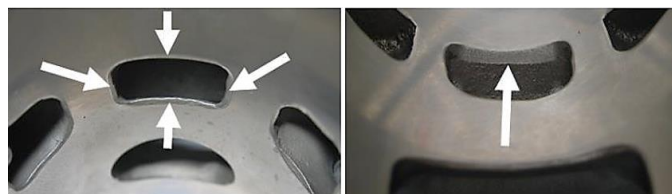



5.5.2.3 The flange for the exhaust socket may show either cast finish or machined surface. Machined surface can be either flat or show a circular sealing bump.



5.5.2.4 The top edge of the exhaust port may show either just a cast finish surface (left picture) or signs of a CNC machining (central picture) or signs of CNC machining in combination with signs of manual grinding (right picture).



The exhaust port may show partial manual grinding done by the manufacturer to eliminate minor casting defects and/or to eliminate the NIKASIL burr at the end of the NIKASIL plating (see above right picture).

**5.5.2.5 Single Core Cylinder**

Cylinders marked 223994, 223993 and 613933 may show in the inlet port a linear texture.

*Single Core Cylinder showing linear structured cast surface finish:*

*Previous manufacturing method showing cast surface finish:*

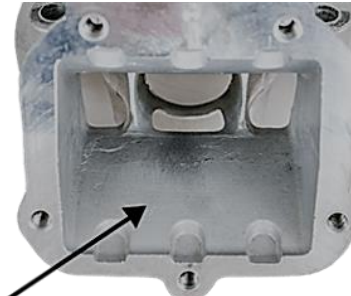
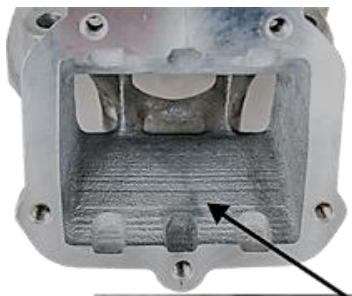

Cylinders marked 223994 and 223993 with linear texture in the inlet port show a fully CNC machined exhaust port and a fully CNC machined top edge of the central boost port.



### 5.5.3 Exhaust port shape

The horizontal and vertical dimensions of the exhaust port have to be checked with the template, marked with 676245\*.

The template has to be moved in horizontal and vertical Position as far as possible into the exhaust port.

In both directions, the template may not touch the flange for the exhaust socket.

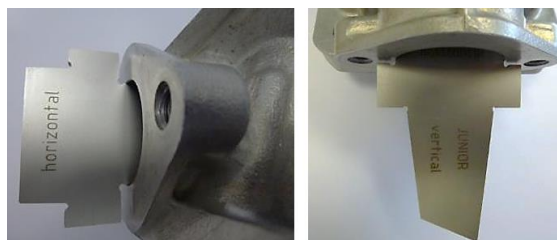

### 5.5.4 Exhaust port timing

The "exhaust port timing" (distance from the top of the cylinder to the top of the exhaust port) has to be checked by means of the template (ROTAX 277402).

Insert the template into the cylinder and move the template (at the highest point of the exhaust port) as far as possible into the exhaust port.

In this Position the template may not touch the cylinder wall.

Take care to use the correct gauge for: Senior MAX



## 5.6 INLET SYSTEM

### 5.6.1 Reed Valve Assembly

The reed valve assembly is equipped with 2 petal stops and 2 reeds, each having 3 petals.

	Thickness	Tolerance
<b>Reed Valve</b>	0,6 mm	+0,10 mm -0,10 mm

Flattening of the curved reed valve stopper plates is forbidden.

The minimum gap between the 2 stopper plates must be greater than 17.00mm.

The measurement must be taken using a digital calliper from the inside surface of the stopper plates in line with the middle of each reed petal, as indicated by the red lines in the picture.



### 5.6.2 Inlet manifold

Some factory flash removal may be present at the conjunction of the inside contour and the carburettor stop mounting face. This is a manual trimming operation consisting of a small corner break of less than 3 mm in width. No additional grinding or machining is permitted.

#### 125 Senior MAX:

Inlet manifold marked with the identification code "267915" and the name "ROTAX" or just "267916".



## 5.7 CRAKSHAFT

### 5.7.1 Con rod

	Length	Tolerance
<b>Stroke</b>	54,5 mm	+0,10 mm -0,10 mm

Con rod has to show forged numbers "213", "365", "367" or "362" on shaft.

Shafts of con rods "213", "365" and "367" are not machined and are copper plated.

Shaft of con rod "362" is not copper plated and is blank (grey/brown).

Grinding or polishing of shaft of con rod is not permitted.



### 5.7.2 Ignition signal on crankshaft

Fit the template (Rotax 277391) on the crankshaft.

Align the hole in the template for the big end pin with the big end pin of the crankshaft.

The two edges of the signal machining on the crankshaft must be in line ( $\pm 0,5$  mm) with the corresponding edges (MAX) of the template.



### 5.7.3 Crankshaft main bearings

Crankshaft main bearing 6206 from FAG is allowed only.

Must be marked with code 579165BA, Z-579165.11.KL or Z-579165.21.KL

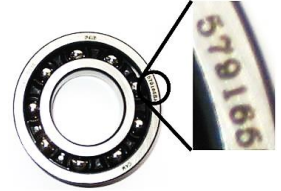

### 5.8 BALANCE SHAFT

Balance shaft and balance gears must be installed.

Balance shaft must show casting code 6237948 or 6237949 on surface (1).

Surface (1) is not machined and must show cast surface.

The minimum weigh of the dry balance shaft must not be lower than: 255 grams.

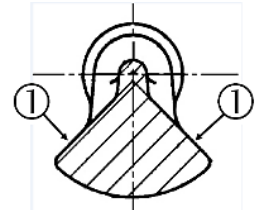

### 5.9 Crankcase

As supplied by the manufacturer.

No grinding/polishing is permitted in the two main transfer passages as well as in the crank area.

Machining maybe evident in the crankcases in the area identified in the picture.

Uncoated or black coated crankcases are legal to be used.



## 6. TECHNICAL SPECIFICATION OUTSIDE THE ENGINE SEAL FOR ROTAX MAX KART ENGINES

It is the responsibility of the competitor to check all components outside the engine seal, to assure that his equipment is conforming to the technical specification below!

### 6.1 BALANCE DRIVE

Steel balance gears only (minimum width = 8,8 mm) are legal to be used.

Balance gears must be installed and must be aligned according to the instruction in the repair manual.

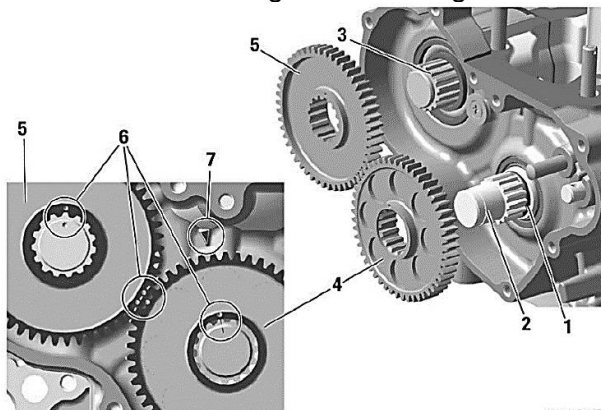

KA\_125\_0270

### 6.2 CENTRIFUGAL CLUTCH

#### 6.2.1 Components

Engagement speed of centrifugal clutch at maximum 4.000 rpm (the kart without driver must start to move).

Two versions of clutch (Item 1, with and without holes) are legal to be used.

Both versions are marked with the wording "ROTAX".

O-ring (Item 2) must be fitted and must assure an appropriate sealing between the clutch drum and the needle/plain bearing.

Two versions of clutch drum (Item 3) are legal to be used.

Both versions are marked with the wording "ROTAX".

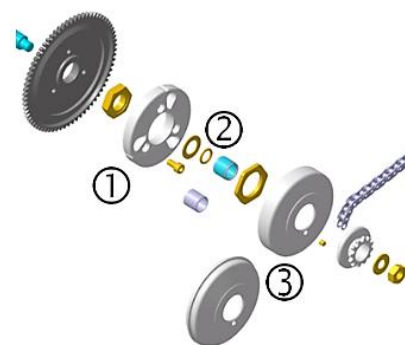

Signs of emission of grease or substance from the needle/plain bearing into the clutch drum may not exceed the picture beside.

Contact area between clutch and clutch drum has to be dry at any time – no lubrication allowed.



#### 6.2.2 Clutch dimensions

Thickness of clutch shoe (A):

Minimum = 24,10 mm

Measurement must be done at the 3 open ends of the clutch, 5 - 10 mm from the machined groove (all clutch shoes must be completely closed at measurement - no gap).

Height of clutch (B):

Minimum = 11,45 mm

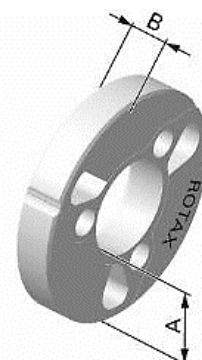

Clutch drum Outer diameter (C):

Minimum = 89,50 mm

Diameter must be measured with a sliding calliper just beside the radius from the shoulder (not at the open end of the clutch drum).

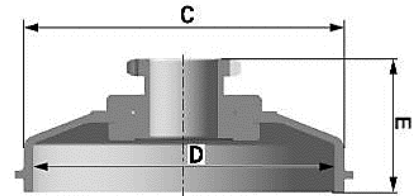

Clutch drum Inner diameter (D):

Maximum = 84,90 mm

Diameter must be measured with a sliding calliper. The measurement must be done in the middle of the clutch drum (in the contact area between clutch and clutch drum).

Clutch drum Height (E) with sprocket / primary gear

Minimum = 33,90 mm

### 6.3 EXHAUST VALVE

System must be used with all components fitted as shown in the illustration.

The cylinder protection plate (45) is optional to use it.

Bellow (10) must have green colour.

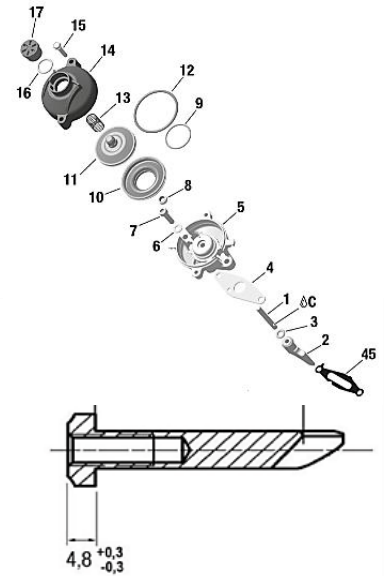

#### 6.3.1 Dimensions

Item 2	Length	Tolerance
<b>Exhaust Valve</b>	36,5 mm	+0,20 mm -0,30 mm
<b>Width of Collar</b>	4,8 mm	+0,30 mm -0,30 mm

#### 6.3.2 Distance of exhaust valve flange at cylinder to piston

Turn crankshaft until the piston just closes the exhaust port. Insert the exhaust valve gauge (Rotax 277030) as shown in the picture until it stops at the flange. At the contact area between exhaust valve gauge (Rotax 277030) and the flange of the cylinder, a feeler gauge 0,05 mm may not fit between the gauge and the flange.

The measurement must be performed outside the exhaust valve contact area indicated in red.

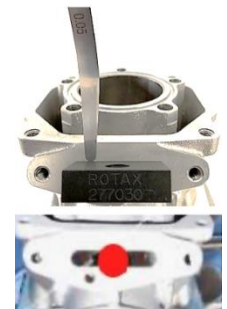

#### 6.3.3 Impulse nozzle

Fitting an original impulse nozzle (1) into the pressure hose is an allowed adjustment.

The direction of the impulse nozzle inside the pressure hose is free.

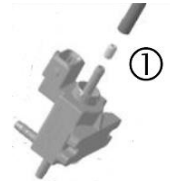

#### 6.3.4 Exhaust valve settings

The electronic timed exhaust valve offers two different settings (A or B) for the opening of the exhaust valve.

(A)...additional ground cable not connected.

(B)...additional ground cable connected.

Both settings are legal to be used.

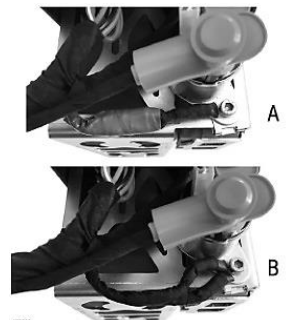

### 6.4 IGNITION SYSTEM

Digital battery ignition system, variable ignition timing, no adjustments possible.

### 6.4.1 Spark plug

NGK GR8DI or NGK GR9DI

DENSO Iridium IW 27 or IW 29 or IW 31 or IW 34

Electrode gap (maximum): Filler gauge 1,00 mm must not fit in between the two electrodes.

### 6.4.2 Spark plug cap

Two versions of the spark plug cap are legal to be used.

Version 1: Black, marked "NGK TB05EMA"

Version 2: Red, marked "NGK" or "ROTAX".



### 6.4.3 Pick-up

The marking of the pick-up must show the following numbers in the first line 029600-0710.

A steel ball (diameter 3-5 mm) placed on circular surface of the sensor must stay in the center of the circular surface.



Mounting the pick-up to the crankcase with a gasket additional to the original rubber sealing ring of the pick-up, is a legal specification.

Additional gasket, Rotax 431500, gasket thickness = 0,8 mm

Maximum two gaskets (Rotax 431500) are allowed to be fitted.

Fitting Position of the additional gasket(s):

Crankcase – rubber sealing ring – additional gasket(s) – pick-up.

**NOTE:** It is not necessary to install any additional gasket/s with the exception of the rubber sealing ring on crankcases with the machined sealing surface for the pick-up sensor.

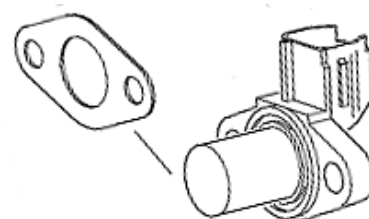

### 6.4.4 Ignition System

Dellorto ignition system is legal to be used only.

Race officials may request at any time that the competitor replaces the electronic box (ECU) with another unit provided by the race administration.

The visual appearance of the ignition coil must be identical with the pictures.

Ignition coil must show 2 pins at the terminal.

The ignition coil is still legal to be used also if one or both stickers are faded or removed.

Minimum length of the high-tension cable of the ignition coil is 210 mm (from outlet of ignition coil to outlet of spark plug connector = visible length of cable).

Ignition coil (same for all engines) with separate electronic box (ECU, specific for every engine).

Ignition coil and ECU (and magnet valve, for 125 Senior MAX) must be fitted with all components according to the illustrations below.



In case the mounting bracket is in conflict with a chassis component, the additions of 2 spacers, one per mounting hole, with a maximum thickness of 20 mm between the mounting bracket and the gearbox cover is allowed.



### 6.4.5 ECU

The electronic control unit (ECU) is labelled with stickers and is still legal also if the sticker is unreadable or disappeared.

125 Senior MAX: "666815" or "666814"

The ECU must be checked with the ECU tester (Rotax 276230) according to following procedure.

Disconnect engine cable harness from ECU.

Connect ECU tester cable harness to ECU.

Connect energy cable of ECU tester cable harness with the charging connector of engine cable harness.

At every connection with the battery the software version of the ECU tester will be indicated on the display for approx. 2 seconds.

The software version indicated on the display must be 2V00.

Start the test by pressing the button "✓" on the ECU tester.

After approx. 3 second the type of ECU ① that is actually tested will be indicated in the second line of the display.

After approx. 30 seconds the result ② of the test will be indicated in the first line of the display.

The ECU tester must indicate following results:

#### 125 Senior MAX category

- ① 666814MAX or 666815MAX
- ② !! Test OK !!



## 6.5 BATTERY, BATTERY FIXATION AND WIRING HARNESS

Original batteries with following specification only are legal to be used.

YUASA YT7B-BS (with and without Rotax branding)

ROTAX RX7-12B or RX7-12L or ROTAX LiFePo4 (lithium iron phosphate type)

Battery must be fitted with an original battery clamp and battery cover (according to illustrations) and must be fixed to the chassis with both clamps (all 4 screws). Battery clamp with or without cable support is legal for use.

Battery clamp must be mounted on the left side of the Chassis, next to the seat.

It is allowed to use both versions of the Rotax original wiring harness: version 1 (Rotax ref. 666830/666831) or version 2 (Rotax ref. 666835/666836).

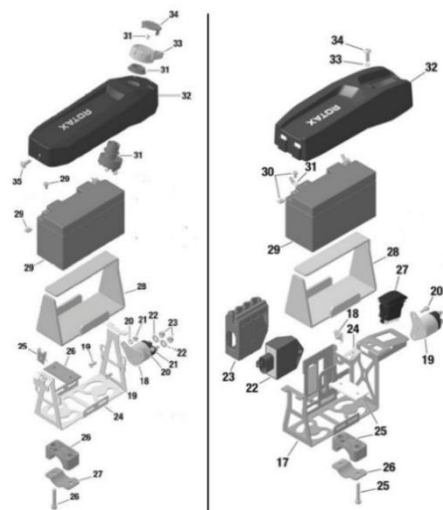

## 6.6 INTAKE SILENCER

Intake silencer with integrated, washable air filter must be used with all parts as shown at the illustration and has to be mounted on the support bracket with two screws (in dry and wet condition).

Intake silencer tube (Pos 2) and carburettor socket (Pos 6) are marked with the wording "ROTAX".

Intake silencer case bottom is marked on the inside with "225015".

Intake silencer case, top is marked on the inside with "225025".

Air filter (Pos 4) must be installed as shown in the illustration between the two holders (Pos 3) and must cover the complete area of the intake silencer case bottom (Pos 1).

During wet condition, it is not allowed to attach anything to the air box to protect the air inlet from water spray.

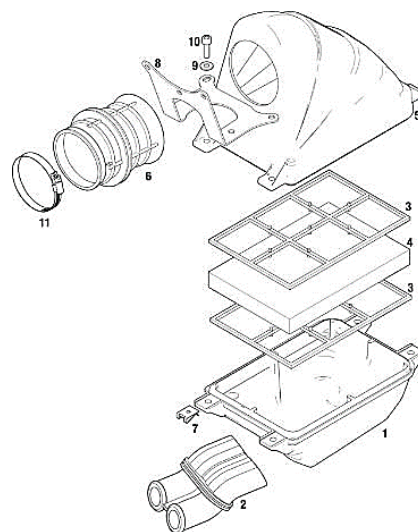

Three versions of original air filters (Pos 4) are legal to be used:

- Single layer (Black)
- Double layer air (Green/Orange)
- Double layer (Green/Dark green) marked "Twin Air"

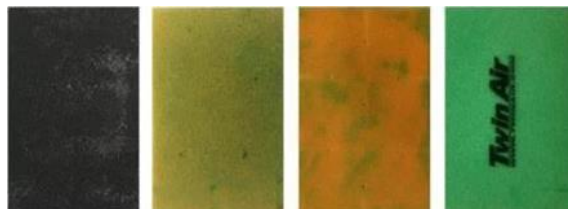

Depending on the degree of oil-lubrication colours may alter slightly or the surface becomes stained (see examples).

## 6.7 CARBURETTOR

Dellorto carburettor, housing must show the cast wording "VHSB 34"

Carburettor housing is stamped with "XS".

The complete inlet bore of the carburettor must show cast surface.

Optional carburettor plug screw marked "ROTAX" (ROTAX part no. 261 030) is legal to be used.

The two vent fittings must be connected with the original air vent hose min 155 mm (Rotax 260260). The location of the opening has to be placed at the rear side of the carburettor.

Settings of the carburettor adjustment screws (idle and idle air) are free.

The Position of the jet needle is free.

All jets must be correctly seated and securely fitted at any time (tightened)!

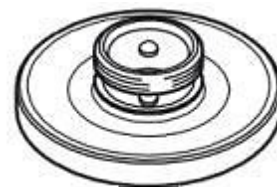

Any Dellorto main jet number even if not offered from Rotax is legal to be used.

The complete inlet bore of the carburettor housing must show cast surface.

The venturi hole of the carburettor insert can show signs of a CNC control machining.

Carburettor insert maybe used with 1 or 2 gaskets placed between the insert and the body of the carburettor.

**Carburettor can be used with and without fuel sieve in the carburettor housing.**

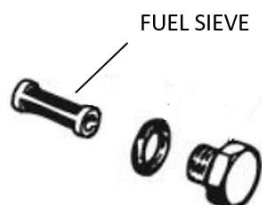



6.7.1 The height of the two arms of the float lever must be within the slot of the carburettor gauge (Rotax 277400) by their normal weight measured at carburettor housing without gasket in reverse upright position.



6.7.2 Needle valve assembly stamped "150".  
Needle of needle valve marked with diamond symbol "INC" only.



6.7.3 Start jet is stamped with the digits "60".

6.7.4 Carburettor slide shows digits "45" in casting.

6.7.5 Jet needle must be stamped with "K57".

6.7.6 Two floats marked "4,0 gr" are legal to be used only.

6.7.7 Needle jet stamped with "DP267".

- a) Total length: 51,00 +/- 0,50 mm
- b) Bottom Section length: 33,00 +/- 0,45 mm
- c) Top Bore diameter: 2,67 +/- 0,10 mm

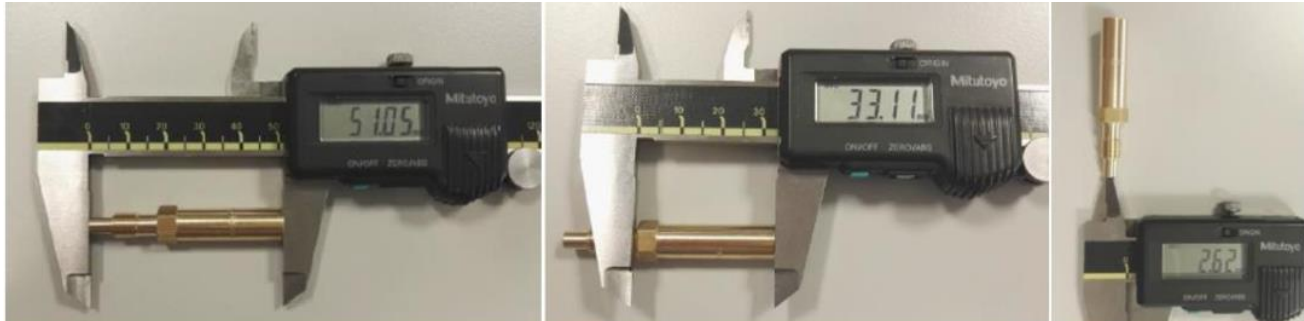

6.7.8 Idle jet has to be stamped with 60.  
Plug gauge 0,65 mm may not enter the bore  
(use jet gauge set Rotax part no. 281 920).

6.7.9 Idle emulsion tube has to be stamped with 45.  
Plug gauge 0,50 may not enter the central bore.  
(use jet gauge set Rotax part no. 281 920)



### 6.7.10 Atomizer

Remove atomizer from carburettor body by means of venturi tool set (Rotax part no. 676 034)

- a) Total length: 23,75 +/- 0,35 mm
- b) Cylindrical length: 15,75 +/- 0,25 mm
- c) Cutaway dimension: 5,80 +/- 0,30 mm
- d) Cross Bore dimension: 5,00 +/- 0,15 mm



6.7.11 Carburettor insert must show stamping: "12,5".



- a) Angular bore of carburettor insert  
Plug gauge 0,60 may not enter the bore  
(use jet gauge set Rotax part no. 281 920).
- b) Vertical bore of carburettor insert  
Plug gauge 1,30 may not enter the bore  
(use jet gauge set Rotax part no. 281 920).

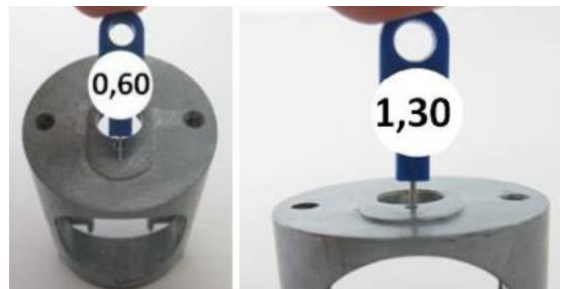

### 6.8 FUEL PUMP

MIKUNI diaphragm pump, (see picture) must be used and must be mounted as shown in the illustration.

Fuel pump must be mounted on the bottom side of the support bracket for the intake silencer.

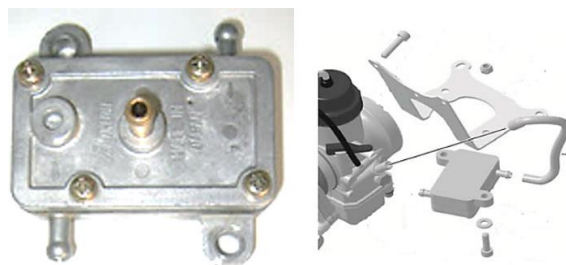

### 6.9 FUEL FILTER

Two versions of original fuel filter are legal to be used (see pictures).

A fuel filter is mandatory to be installed. The fuel filter must be mounted between the fuel tank and the fuel pump.

Except the fuel line, the fuel pump and the original fuel filter no additional parts are legal to be mounted between fuel tank and carburettor.



## 6.10 RADIATOR

The removal of the thermostat from the cylinder head cover is an allowed modification.  
 Radiator must be mounted with all components as shown in the respective illustration.  
 To apply tape (neutral tape without advertising only) around the radiator is an allowed modification to control the air flow through the radiator.  
 Tape may not be removed from the radiator during operation on the track.  
 Any other non-original device to control the air flow through the radiator is prohibited.  
 The dimensions of the radiators are for reference purposes only.

The radiator must be mounted on the right side of the engine.  
 Three different versions as shown in the illustrations are legal to be used.

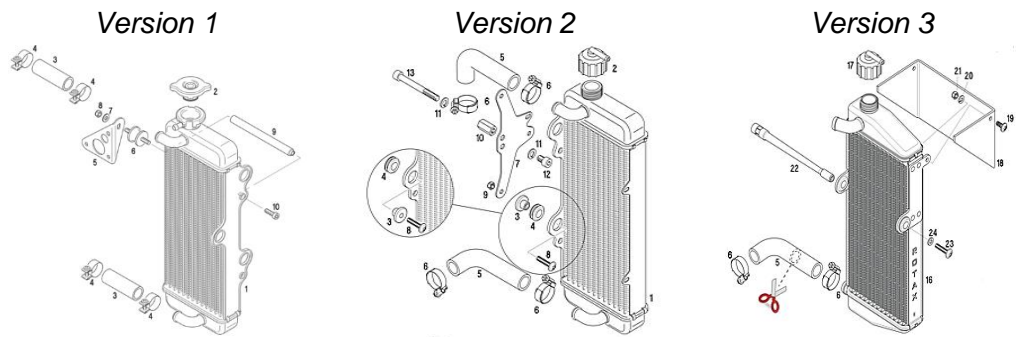

Cooling Area

<b>Height [mm]</b>	290	290	290
<b>Width [mm]</b>	133	133	138
<b>Thickness of radiator [mm]</b>	32	32	34

### Version 2

The support plate (Pos 7) enables two different mounting positions (height) of the radiator.  
 Both mounting positions are legal to be used.

### Version 3

Radiator must be stamped on the side with the wording "ROTAX".  
 To remove the original flap is an allowed modification.

## 6.11 ENGINE COOLANT

Plain water without any additives has to be used.

## 6.12 EXHAUST SOCKET

Only exhaust sockets with gasket ring (ROTAX ref. 450360) are legal to be used.

Only Rotax part no. 273190 is allowed to be used.

The measurement (C) must be at least 15,5 mm.

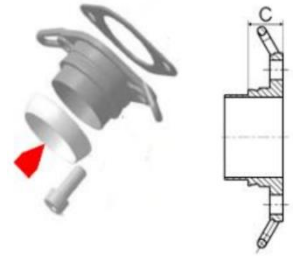

## 6.13 EXHAUST SYSTEM

The use of maximum 4 pieces (minimum 2 pieces) of original Rotax exhaust springs, to fix the exhaust system to the cylinder is allowed. (a "safety wire" in the exhaust flange or silencer area is not allowed).

Original exhaust system as supplied by Rotax is mandatory to be used for the relevant class.

Welding at the exhaust system is only allowed in the case of a repair. Only repairs that return the components to its original shape or form are allowed.

Allowed modifications on the original exhaust systems are:

- Replacing the original rivets of the silencer end cap by 4 mm metric screws and corresponding locking nuts. The 3 x fixations (rivets, bolts and locking nuts) must be always secured tight to ensure a sealing between the perforated tube and exhaust system. The perforated tube must be fully inserted into the exhaust system (see top, right picture for reference). External protrusion of the outer sealing ring of the perforated tube is forbidden. (Indicated by the red arrow)
- If the event requires the Exhaust / Perforated tube to be sealed, the seal must be passed through a 4<sup>th</sup> hole (maximum 4 mm diameter). The hole must be in a position that avoids the leaking of exhaust gasses as indicated in the picture on the right. The perforated tube must be always secured tightly to the exhaust at 3 points.
- Replacing the isolating mat (just one original isolating mat may be fitted – Rotax part no. 297982) inside the silencer and the silencer end cap with perforated tube by original Rotax spares parts.
- Welding a socket (in a distance of 50-80 mm from the ball joint) on the top of the exhaust system for measuring the exhaust gas temperature.
- Addition extra elements after the original silencer for further noise reduction.  
Additional to the standard isolation mat a steel isolation mat (Rotax part no. 297 983) with the square dimension of 165 +10 mm is legal for use (not mandatory) to be assembled underneath the standard isolation mat according to the illustration.
  - Clamp (1) must be fitted at a distance of 18+/-2mm, measured from the end of the tube.
  - Clamp (2) must be fitted at the end area of the steel isolation mat.
  - The measurement 10-12 mm from the end of the perforated tube to the beginning of the steel isolating mat is a specification for assembly purpose only!
  - Both clamps (1 and 2) are mandatory to be fitted and tightened.

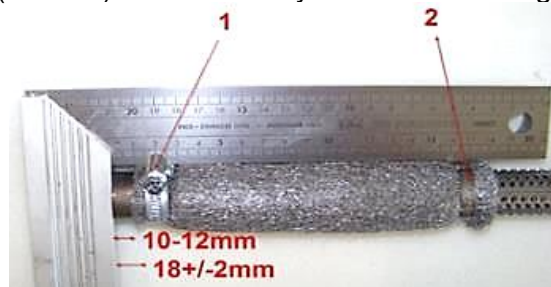
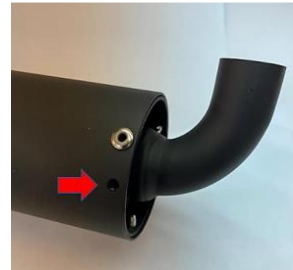

### 6.13.1 Damage Limits

Damage to the tuned pipe is not permitted unless deemed by the technical officials to have occurred during regular operation and in line with the following dimensions:

For any indentation close to the brake disc (A), the depth must not exceed 10 mm.

For any indentation between the exhaust socket and the elbow of the expansion chamber (B) the depth must not exceed 3 mm.

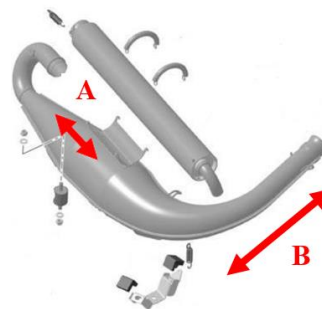

### 6.13.2 125 Senior MAX Exhaust

The silencer must be mounted in a position where the direction of the 90° elbow outlet (direction of the hot exhaust gasses) does not harm any component of the chassis.

A steel ball with 27.5 mm diameter must pass through the tuned pipe from the inlet and through the 180-degree elbow completely (silencer disconnected).

To drill an extra hole in the exhaust retaining bracket (Rotax Part No. 651070 MAX) for attachment of a second exhaust spring is a legal modification.

To fit a 3rd original spring (crosswise at the ball joint connection between 180° elbow and silencer) is an allowed option.

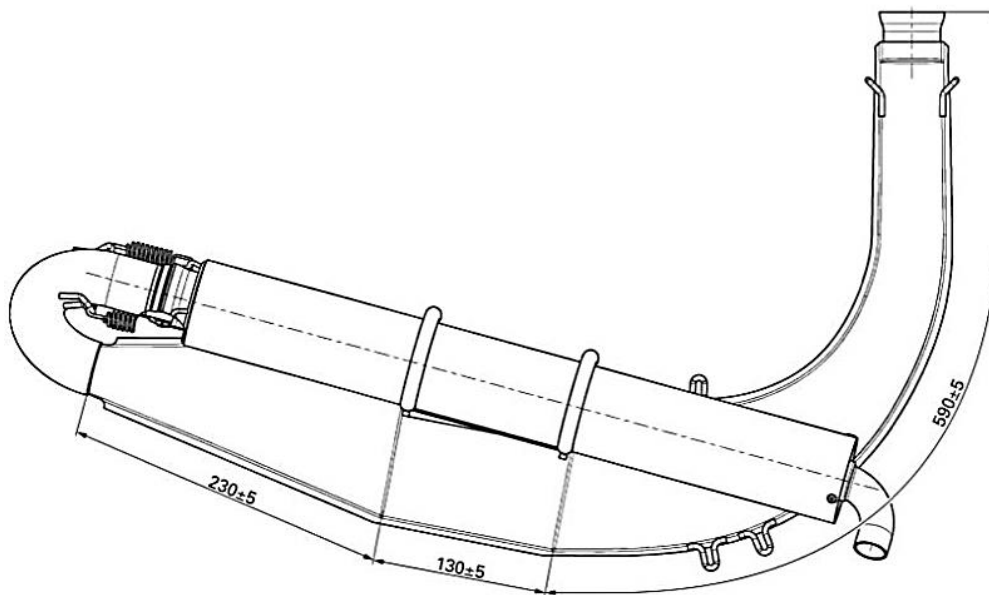

6.13.3 The only legal Isolation matting for 125 Senior MAX is:

ROTAX part number 297982	Measurement	Tolerance
<b>New size minimum</b>	480 x 270 mm	+10 mm -10 mm
<b>New weight</b>	207 Gram	+31 Gram -31 Gram
<b>Used weight (old)</b>	245 Gram	+105 Gram -105 Gram

----- END OF TECHNICAL REGULATION -----